

LECTURE NOTES ON

# THERMAL ENGINEERING - 1

## **3RD SEMESTER MECHANICAL ENGINEERING**

**PREPARED BY:-**  
**Mr. B.SAI SANTOSH**  
**LECTURER**  
**GOVT. POLYTECHNIC,**  
**KORAPUT**

## **CHAPTER 1:**

### **CONCEPTS AND TERMINOLOGY**

#### ▣ **Thermodynamics**

It is defined as the science of heat energy transfer and its effect on physical property of the substance.

OR

It may be defined as the science which deals with the conversion of heat into mechanical work or energy by using a suitable medium.

#### ▣ **Thermodynamic System**

**System:** A system is defined as any quantity of matter or a region in space having certain volume upon which our attention is concerned in analysis of problem.

**Surrounding:** Anything external to the system constitute as surrounding.

**Boundary:** System is separated from the surrounding by system boundary. This boundary may be fixed or movable.

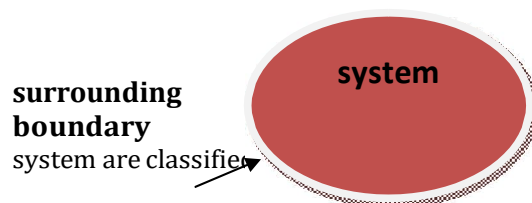

▣ Open system

▣ Closed system

▣ Isolated system

#### **Open System**

It is also known as *flow system*. Open system is one in which both mass and energy cross the boundary. Open system is also called control volume. Ex- reciprocating air compressor, turbine, pump etc.

#### **Closed System**

It is also known as *non-flow system*. In this system the mass within the boundary

remains constant only energy interaction takes place with respect to the surrounding. Ex  
– Cylinderpiston arrangement, Tea kettle.

**Isolated System**

An isolated system is one in which there is no interaction between the system and surrounding. There is no mass and energy transfer across the system. Ex- Universe, thremoflask etc.

## MACROSCOPIC AND MICROSCOPIC APPROACH

Study of thermodynamics is done by two different approaches.

- ▣ **Macroscopic approach:** The term macroscopic is used in regard to larger units which is visible to the naked eye. In macroscopic approach certain quantity of matter is considered without taking into consideration the events occurring at molecular level. In other words macroscopic approach is concerned with overall behaviour of matter. This type of study is also known as *classical thermodynamics*.
- ▣ **Microscopic approach:** In microscopic approach matter is considered to be composed of tiny particles called molecules and study of each particle having a certain position, velocity and energy at a given instant is considered such a study is also called as *Statistical thermodynamics*.

## CONCEPT OF CONTINUUM

The system is regarded as a continuum i.e. the system is assumed to contain continuous distribution of matter. Thus, from the continuum point of view, the matter is seen as being distributed through space and treats the substance as being continuous disregarding the action of individual molecules. There are no voids and values of action of many molecules and atoms.

## THERMODYNAMIC PROPERTY

- ▣ **PROPERTY-**A thermodynamic property refers to the characteristics by which the physical condition or state of a system can be described such as pressure, volume, temperature etc. & such characteristics are called properties of a system.
- ▣ **PRESSURE-**Pressure is defined as force per unit area.

Units of pressure are as follows In S.I Pascal (Pa) and  $1 \text{ Pa} = 1 \text{ N/m}^2$   
 $1 \text{ Bar} = 10^5 \text{ N/m}^2 = 100 \text{ KPa}$   
 $1 \text{ ATM} = 760 \text{ mm of Hg or } 1.013 \text{ bar or } 101.325 \text{ KPa}$

- ▣ **TEMPERATURE-**The temperature is a thermal state of a body which determines the hotness or coldness of a body. The temperature of a body is proportional to the stored molecular energy i.e. the average molecular kinetic energy of the molecules in a system.  
Units of temperature are degree Celsius or Kelvin.

## Intensive and Extensive Property:

- ▣ **Intensive property:** The properties which are independent of mass of the system are known as intensive properties. Its value remains the same whether one considers the whole system or only a part of it. The intensive property includes pressure, temperature, specific volume, specific energy, specific density etc.

- Extensive property: the property which depends upon mass of the system are known as extensive property. The extensive properties include volume, energy, enthalpy, entropy etc.

**State:** The condition of physical existence of a system at any instant of time is called state.

**Thermodynamic Processes:**

When any property of a system changes, there is a change in state and the system is then said to have undergone a thermodynamic process.

The commonly used processes are:

1. Isochoric Process – The process which takes place at constant volume is said to be isochoric process.
2. Isobaric Process – The process which takes place at constant pressure is said to undergo an isobaric process.
3. Isothermal Process- The process which takes place at constant temperature is said to undergo an isothermal process.
4. Adiabatic Process- The process where there is no heat transfer between the system and the surrounding. The reversible adiabatic process is known as isentropic process.

The other processes are polytropic process, throttling process, free expansion process and hyperbolic process.

**Thermodynamic Cycle:**

When a process is performed in such a way that the final state is identical with the initial state, it is then known as a thermodynamic cycle or cyclic process.

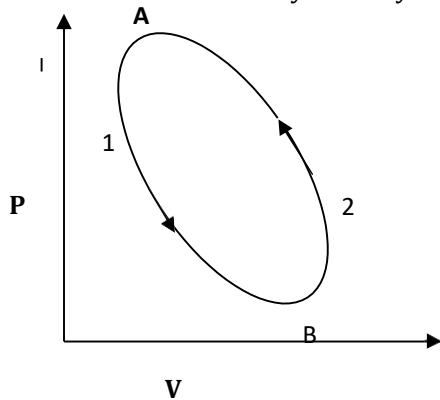

In the fig above:

and **A-2-B** represents *process*

Whereas **A-1-B-2-A** represent a *thermodynamic cycle*.

**THERMODYNAMIC  
EQUILIBRIUM:**

A system is said to be in thermodynamic equilibrium when no change in any macroscopic property is registered, if the system is isolated from its surrounding.

Thermodynamics mainly studies the properties of physical system that are found in equilibrium state.

A system will be said to be in thermodynamic equilibrium if the following three conditions of equilibrium is satisfied.

- a) Mechanical Equilibrium
- b) Chemical Equilibrium
- c) Thermal Equilibrium

*Mechanical Equilibrium*- when there is no unbalanced force on any part of the system or in-between the system and surrounding then the system is said to be in mechanical equilibrium. For example if the pressure is not uniform throughout the system, then internal changes in the state of the system will take place until the mechanical equilibrium is reached.

*Chemical Equilibrium*- when there is no chemical reaction or transfer of matter from one part of the system to another such as diffusion or solution, then the system is said to exist in a state of chemical equilibrium.

*Thermal Equilibrium*- when there is no temperature difference between the parts of the system or between the system and the surrounding, it is then said to be in thermal equilibrium.

**REVERSIBLE PROCESS:**

A process which can be reversed in direction and the system retraces the same continuous series of equilibrium states it is said to be reversible process. A reversible process should be carried out with absolute slowness, so that the system will be always in equilibrium. In actual practise a reversible process cannot be attained, but it can be approximated as closely as possible. For example a gas confined in a cylinder with a well lubricated piston can be made to undergo a reversible process by pushing or pulling the piston in slow motion.

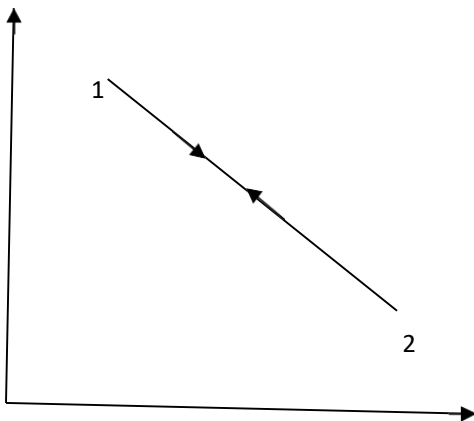

**IRREVERSIBLE PROCESS**

A process in which the system passes through a sequence of non-equilibrium states i.e. The property such as pressure, volume, temperature is not uniform throughout the system it is known as an irreversible process. This process will not retrace the reverse path to restore the original state. The heat transfer by convection, combustion of air and fuel etc are few examples of irreversible process.

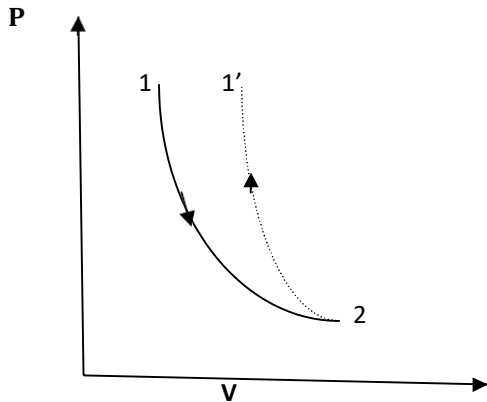

**QUASI-STATIC PROCESS**

The word quasi means *almost*. This process is a succession of equilibrium states and infinite slowness is the characteristic feature of quasi-static process. A quasi-static process is also called as reversible process, the basic difference is that in a quasi static process not all the points but almost major points are in equilibrium condition.

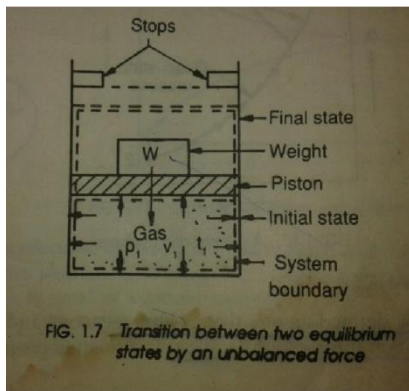

**Fig 1**

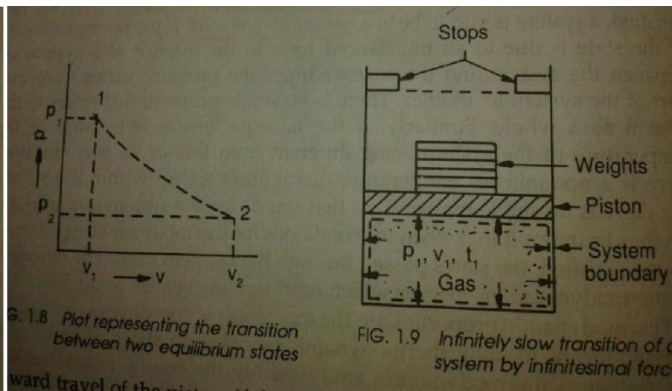

**Fig 2**

Let us consider a system of gas contained in a cylinder as shown in fig 1 . The system is initially an equilibrium state. The weight W on the piston just balances the upward force exerted by the gas. If the weight is removed there will be an unbalanced force between the system and the surrounding, and the piston will move upward till it hits the stops .the system will be again in a equilibrium state but if the same process as shown in fig 2 is done by slowly removing very small pieces of weight one by one then the piston will move upward slowly thus the system will be in equilibrium.

## CHAPTER

### 2:

#### **ENERGY AND WORK TRANSFER**

A closed system interacts with the surrounding by energy transfer and this energy transfer takes place in two ways i.e. *Work transfer* and *Heat transfer*.

Heat and work are the main mode of energy transfer and there are certain similarities and differences between heat and work.

- ▣ The heat and work are boundary phenomena. They are observed at the boundary of the system.
- ▣ When a system undergoes a change in state, heat transfer or work done may occur.
- ▣ Heat and work are path function and depends upon the process. Hence they are not thermodynamic property and are inexact differential.
- ▣ Work is said to be *high grade energy* and heat *low grade energy*. The complete conversion of low grade energy into high grade energy is impossible.

#### **Work Transfer**

The action of a force on a moving body is identified as work. For the work transfer the system has to be such selected that its boundary just move. There cannot be work transfer in a closed system, without moving the system boundaries. In a cylinder piston arrangement the top of the system is moving system boundary and the work is transferred by the movement of the piston.

Work done by the system is considered to be *positive* and work done on the system is taken as *negative*.

Work done = force X displacement

Unit of work: Newton-meter (N-m) or Joule(J)

The rate at which work is done upon or by the system is known as *power*. The unit of power is J/s or watt.

#### **PdV work or Displacement Work**

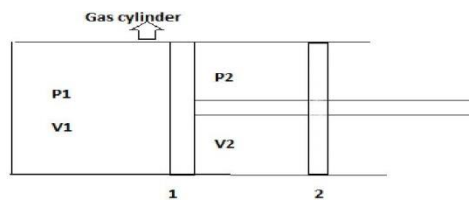



Let us consider a gas in the cylinder as shown in the fig above. Let the system initially be at pressure  $P_1$  and volume  $V_1$ . The system is in thermodynamic equilibrium, the piston is the system boundary which moves due to gas pressure. Let the piston move out to a new final position 2 which is also in thermodynamic equilibrium specified by pressure  $P_2$  and volume  $V_2$ . When the piston moves an infinitesimal distance  $dl$  if  $a$  be the area of the piston.

The force  $F$  acting on the piston will

$$F = p \times a$$

The amount of work done by the gas on the piston will be

$$dW = F \cdot dl = p \times a \times dl = p dV$$

where  $dV = a \times dl$

when the piston moves out from position 1 to position 2 then the amount of work done by the system will be

$$W_{1-2} = \int_{v_1}^{v_2} p dv$$

The above equation represents the displacement work.

Displacement work applied to different thermodynamic process

### 1. Isobaric process

$$W_{1-2} = \int_{v_1}^{v_2} p dv$$

$$= p(v_2 - v_1)$$

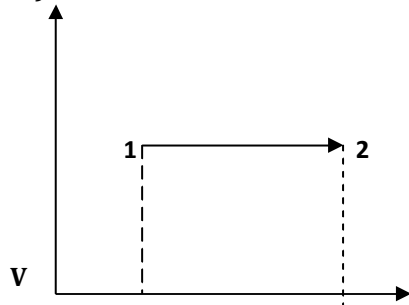

### 2. Isochoric process

$$W_{1-2} = \int_{v_1}^{v_2} p dv$$

$$= 0$$

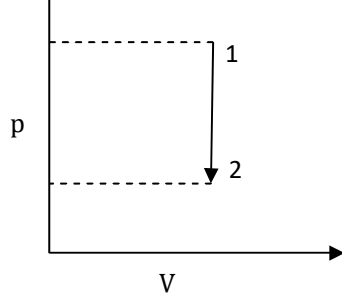

### 3. Isothermal process

In this process  $pV = \text{constant}$   
 $pV = P_1V_1 = C$   
 $P = P_1V_1/V$

$$W_{1-2} = \int_{v_1}^{v_2} p \, dv$$

$$W_{1-2} = p_1V_1 \int_{v_1}^{v_2} \frac{dV}{V}$$

$$= p_1V_1 \ln \frac{p_1}{p_2}$$

### 4. Polytropic process

The process in which expansion and contraction takes place according to the law

$$pV^n = CpV^n = p_1v_1^n = p_2v_2^n = C$$

$$W_{1-2} = \int_{v_1}^{v_2} p \, dv$$

$$= \int_{v_1}^{v_2} (p_1V_1^n / V^n) \cdot dV$$

$$= p_1V_1^n \left[ \frac{V^{-n+1}}{-n+1} \right]_{v_1}^{v_2}$$

$$= [p_2V_2^n * V_2^{1-n} - p_1V_1^n * V_1^{1-n}] / (1-n)$$

$$= (p_1V_1 - p_2V_2) / (n-1)$$

## HEAT TRANSFER

Heat is defined as the form of energy that is transferred across a boundary by virtue of temperature difference between the system and the surroundings.

If the heat flows into the system or the system receives heat then heat transfer  $Q$  is taken as *positive* and if heat is rejected from the system then  $Q$  is taken as *negative*.

The heat transfer takes place by three different modes

1. Conduction: the transfer of heat between two bodies in direct contact is called conduction. It is a process of heat transfer from one particle of a body to another in the direction of fall of temperature. For example heat transfer through solids is by conduction.
2. Convection : The process of heat transfer from one particle to another by convection currents i.e. transfer of heat between the wall and fluid system in motion. In this case, the particles of the body move relative to each other.
3. Radiation : Heat transfer between two bodies separated by empty space or gases through electromagnetic waves is radiation.

**Sensible heat:** The heat required for change from liquid state to vaporization /boiling point is called sensible heat. It is the amount of heat absorbed by one kg of water, when heated at a constant pressure, from the freezing point (0°C) to the temperature of formation of steam.

**Latent heat:** It is the amount of heat absorbed to evaporate one kg of water at its boiling point without change of temperature.

**Specific Heat :** The amount of heat required to raise the temperature of unit mass of a substance through one degree is known as specific heat.

The unit of specific heat is KJ/kg K

Mathematically heat required to raise the temperature of a body

is  $Q = m C(T_2 - T_1)$  in kJ

Where, m= mass of the substance in kg

C= specific heat in KJ/Kg K

T<sub>1</sub>= initial temperature in degree Celsius or

Kelvin T<sub>2</sub>= final temperature in degree Celsius or

Kelvin

Specific heat at constant volume (C<sub>v</sub>) : It is defined as amount of heat required to raise the temperature of a unit mass of a gas by one degree at constant volume.

Specific heat at constant pressure (C<sub>p</sub>) : It is defined as amount of heat required to raise the temperature of a unit mass of a gas by one degree at constant pressure

## **ENERGY:**

The energy is defined as the capacity to do work. In broad sense energy is classified as *stored energy* and *transient energy*.

The energy that remains within the system boundary is called **stored energy** e.g. potential energy, kinetic energy and internal energy.

The energy which crosses the system boundary is known as energy in transition e.g. heat, work, electricity etc.

## **DIFFERENT FORM OF STORED ENERGY**

1. POTENTIAL ENERGY-The energy posed by a body by a virtue of its position or state of rest is known as potential energy

$$P.E = W \times h = mgh$$

W=weight of the body in N

M=mass of the body in kg

g=acceleration due to

gravity h=height in meter

2. KINETIC ENERGY-The energy posed by a body by virtue of its motion.

Mathematically kinetic energy,

$$K.E = \frac{1}{2} mv^2$$

V=velocity of the body

3. INTERNAL ENERGY -The energy posed by a body or a system by virtue of its intermolecular arrangement and motions of molecules. The change in temperature causes the change in internal energy. It is usually denoted by U.

The sum of the above three energies is the total energy of the system

$$E = P.E + K.E + U$$

But when the system is stationary and the effect of gravity is neglected then P.E=0 and K.E=0.

Thus  $E = U$

I.E the total energy is equal to the total energy of system.

## CHAPTER 3.0

### FIRST LAW OF THERMODYNAMIC

#### Introduction

Heat and work are different forms of the same entity called energy. Energy is always conserved. Energy may enter a system as heat and leave as work and vice-versa.

Energy has two forms-transit energy and stored energy.

The internal energy is the stored energy. Whenever heat and work enters a system, stored energy increases and when heat & work leaves the system stored energy decreases.

#### First law of thermodynamics

Whenever heat is absorbed by a system it goes to increase its internal energy plus to do some external work (Pdv work) i.e.

$$Q = \Delta E + W$$

Where Q is the energy entering a system,  $\Delta E$  increase in internal energy, W – producing some external work.

$$Q = dE + PdV$$

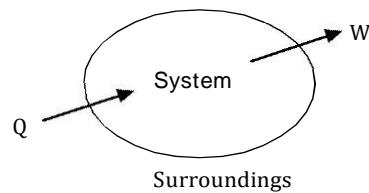

Sometimes more than two energy transfers, so it becomes.

$$Q_1 + Q_2 + Q_3 = \Delta E + W_1 + W_2 + W_3 + W_4$$

#### Sign convention

It will be '+Q' if heat goes into the system and '-Q' if heat goes out of the system +W when it is done by the system and -w is done on the system.

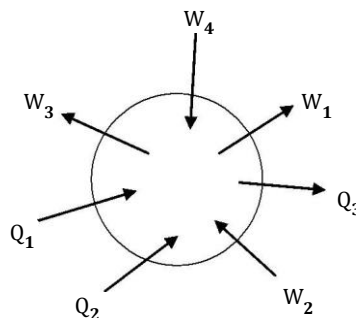

#### Cyclic process

For a cyclic process, the work done is the area enclosed by the PV curve.

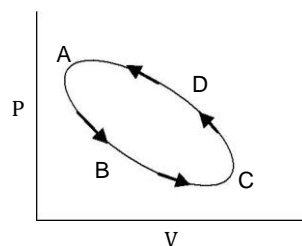

Clock wise = + W  
anticlockwise = - W

## Energy as a system property

Let a system changes from state 1 to state 2 via path A path B and Path C, which as follows

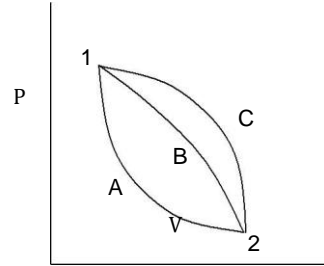

Applying first law of thermodynamics to path A.

$$Q_A = E_A + W_A$$

$$\text{For path B } Q_B = E_B + W_B$$

If process A & B form a complete cycle

$$Q = W$$

$$(Q_A + Q_B) = E_A + E_B + W_A + W_B$$

$$Q = E_A + E_B + W$$

$$E_A = E_B$$

$$\text{Similarly } E_A = E_B$$

$$E_B = E_C$$

So it is independent of path hence a property extensive or in nature.

### Different forms of stored energy

Energy can be stored in a system by two modes.

- (i) Macroscopic mode
- (ii) Microscopic mode

#### (i) Macroscopic mode

In this mode, the mode of stored energy is stored in two forms,

$$E_{KE} = \frac{1}{2} MV^2$$

$$E_{PE} = mgz$$

#### (ii) Microscopic mode

This mode of stored energy refers to energy stored in molecular and atomic structure. Hence it is called molecular internal energy or simply internal energy. Then including

1. Translational KE
2. Rotational KE
3. Vibration energy
4. Electronic energy
5. Chemical energy
6. Nuclear energy

$$L = L_{\text{translation}} + L_{\text{rotational}} + L_{\text{vibration}} + L_{\text{electronic}} + L_{\text{chemical}} + L_{\text{nuclear}}$$

Total energy

$$E = E_{KE} + E_{PE} + U$$

In absence of motion, gravity  $E_{KE} = E_{PE} = 0$

So  $E = U = Q = U = Pdv$

First law for a closed system undergoing a cyclic process.

### Enthalpy concept

Enthalpy is a state property of a system. It is denoted by  $H =$

$$U + Pv$$

It is a point function and an intensive property.

Specific enthalpy is given by

$$h = u + \frac{1}{m} Pv$$

### First law for a steady flow process

#### Steady flow process

A flow process is the one in which a fluid enters the system and then leaves it after a work interaction.

The mass flow rate and energy flow rate across the system boundary are constant.

#### Important terms

Flow work – whenever a certain amount of mass enters a system, an amount of work is required to push the mass into the system and out of it to maintain the continuity of flow.

i.e. Flow work =  $PV$

#### Control Volume

For computation of mass and energy notes during a flow process, it is convenient to focus attention upon a certain fixed region in space called control volume.

#### Control surface

The boundary line defining the control volume is called control surface.

### Stored energy of a system in a flow process

During a steady state flow, there is neither any accumulation of mass nor energy.

$$\dot{m}_{in} = \dot{m}_{out}$$

$$\dot{E}_{in} = \dot{E}_{out}$$

Now, the total energy of a fluid at any section of the control volume.

$$E = U + \frac{1}{2}(MV^2) + mgz$$

$$e = u + \frac{1}{2}v^2 + gz$$



## STEADY FLOW ENERGY EQUATION

As all energy is conserved

Energy<sub>in</sub> + Heat flux = Energy<sub>in</sub> + Work<sub>output</sub> i.e.

$$U_1 + \frac{1}{2} m V_1^2 + mgz_1 + P_1 V_1 = Q + U_2 + \frac{1}{2} m V_2^2 + mgz_2 + P_2 V_2 + W$$

$$U_1 + \frac{1}{2} m V_1^2 + mgz_1 + P_1 V_1 = Q + U_2 + \frac{1}{2} m V_2^2 + mgz_2 + P_2 V_2 + W$$

$$h_1 + \frac{1}{2} V_1^2 + gz_1 + \frac{P_1}{\rho} = Q + h_2 + \frac{1}{2} V_2^2 + gz_2 + \frac{P_2}{\rho} + \frac{W}{m}$$

On the basis of per unit mass flow rate  $\dot{V}$

$$h_1 + \frac{1}{2} V_1^2 + gz_1 + \frac{P_1}{\rho} = Q + h_2 + \frac{1}{2} V_2^2 + gz_2 + \frac{P_2}{\rho} + \frac{W}{m}$$

$$h_1 + \frac{1}{2} V_1^2 + gz_1 + \frac{P_1}{\rho} = Q + h_2 + \frac{1}{2} V_2^2 + gz_2 + \frac{P_2}{\rho} + \frac{W}{m}$$

$$\text{or } h_1 + \frac{1}{2} V_1^2 + gz_1 + \frac{P_1}{\rho} = Q + h_2 + \frac{1}{2} V_2^2 + gz_2 + \frac{P_2}{\rho} + \frac{W}{m}$$

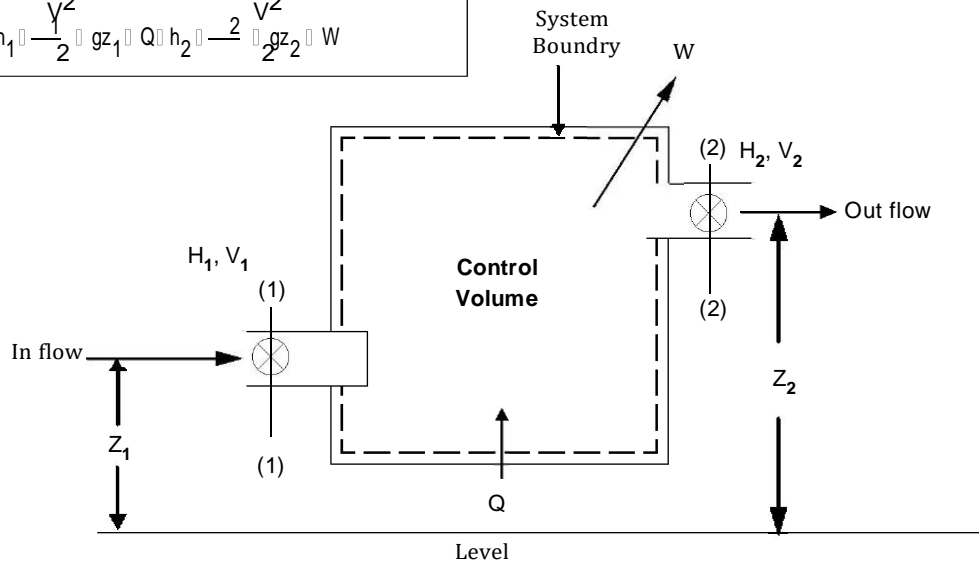

**Fig- Steady flow**

### NOZZLE

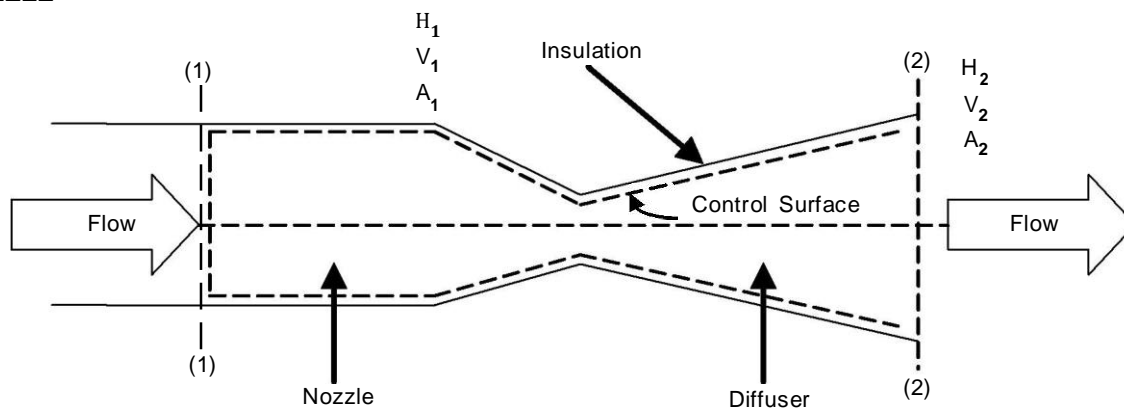

**Fig- A Steady flow process through a nozzle.**

A nozzle is a device used to throttle a fluid whereupon its pressure energy is converted into kinetic energy. The enthalpy of fluid decreases as the velocity of the fluid increases because of a

higher fluid velocity at the nozzle outlet, a nozzle is harnessed to gain a high thrust in rockets and jet engines and drive impulse type steam and gas turbines.

## Compressor

A compressor compresses air or a gas by harnessing external work fed from a prime mover. The increase in the gas pressure is accompanied by the temperature rise. If the compressor is perfectly insulated and the compression is adiabatic then it requires the minor work input to increase the gas pressure. All the generated heat of compression is expanded to compresses the gas as no heat is allowed to escape.

$$\text{So } Q = 0$$

$$\text{Mass flow rate of the gas} = M \text{ and } V_1 = V_2$$

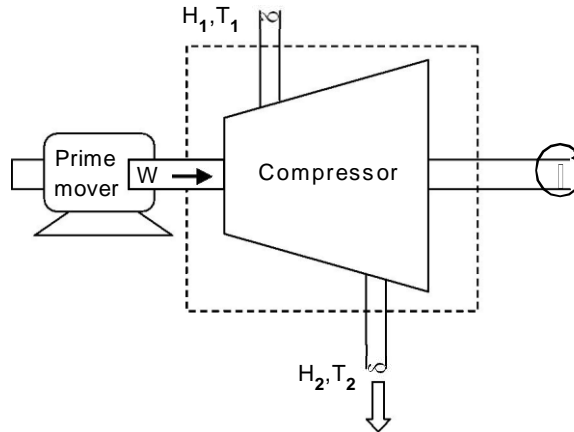

$$Z_1 = Z_2,$$

By applying SFEE  $h_1$

$$= h_2 + (-W_c)$$

(-) sign before  $W_c$  refers to the work done on the gas (system)

$$W_c = M(h_2 - h_1)$$

$$= MC_p (T_2 - T_1)$$

### Example

An air compressor compresses air from  $0.1 \text{ MP}_a / 300 \text{ K}$  to  $1 \text{ MP}_a$ . The compressor casing is well insulated, yet there is a heat loss to the surrounding to the extent of 5% of the compressor work.

Determine air temp at outlet and power input given

$$V_1 = 40 \text{ m/s}, V_2 = 100 \text{ m/s}, A_1 = 100 \text{ cm}^2, A_2 = 20 \text{ cm}^2, C_p = 10^3 \text{ J Kg}^{-1} \text{ K}^{-1}$$

### Solution

$$P_2 V_2 = RT_2 \text{ or } T_2 = P_2 v_2 / R - \text{Specific volume.}$$

$$\text{We have } m_1 = m_2$$

$$\frac{a_1 V_1}{v_1} = \frac{a_2 V_2}{v_2}$$

$$P_1 v_1 = RT_1$$

$$v = \frac{RT_1}{P_1} = \frac{287 \times 300}{0.1 \times 10^6}$$

$$= 0.861 \text{ m}^3 \text{ kg}^{-1}$$

$$\text{and } v_2 = \frac{a_2 V_2}{m} = \frac{20 \times 100}{100 \times 40} \times 0.861$$

$$= 0.4305 \text{ m}^3 \text{ kg}^{-1}$$

$$= 0.4305 \text{ m}^3 \text{ kg}^{-1}$$

$$T_2 = P_2 v_2 / R$$

$$\frac{1 \times 10^6 \times 0.4305}{287} \approx 1500\text{K}$$

$$Z_1 = Z_2$$

$$Q = 5\% W_C$$

$Q$  as rejected

$W =$  W.D on the system

$$H = \frac{1}{2} M V^2 = (Q)$$

$$H = \frac{1}{2} M V^2 = (W) C$$

$$0.5 W_C = W_C$$

$$M(h_2 - h_1) = m(V_2^2 - V_1^2) \quad 1$$

$$0.95 W_C = 0.4646 x C \frac{(T_2 - T_1)}{P} \frac{1}{2} (V_2^2 - V_1^2)$$

$$m = \frac{A_1 V_1}{V_1}$$

$$100 \times 10^4 \text{ m}^2 \times \frac{40 \text{ m}^5 \cdot 1}{0.861} = 0.46457 \text{ kg} \cdot 1$$

$$W_C$$

$$0.4646 \times 10 \cdot (1500 - 300) \cdot \frac{100 \cdot 40}{2}$$

$$59889 / 7 \text{ w}$$

$$588.9 \text{ kw (Ans)}$$

### Nozzle

There is no work output :  $W = 0$

No heat influx or escape  $Q = 0$

For a horizontal disposition

$$Z_1 = Z_2$$

And so the SFEE applied to the nozzle boils down to

$$h_1 + \frac{1}{2} V_1^2 = h_2 + \frac{1}{2} (V_2)^2$$

If  $V_2 = V_1$ , then

$$V_2 = \sqrt{2(h_1 - h_2)}$$

$$\sqrt{2C_p(T_1 - T_2)}$$

## Turbine

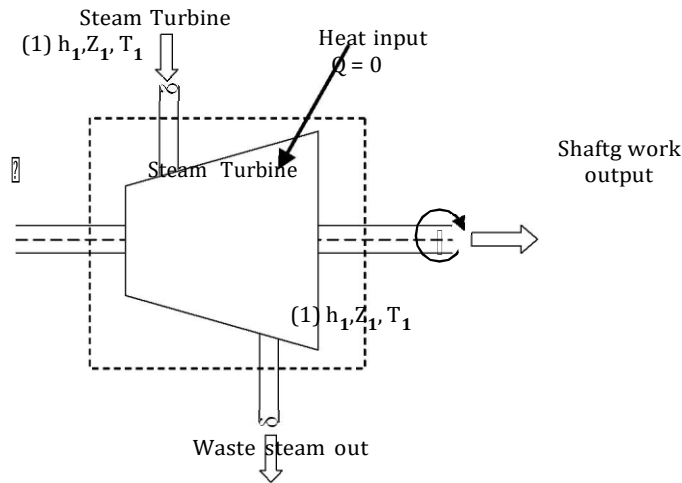

A steam turbine receives a superheated, high pressure steam that experiences its enthalpy drop as the steam passes over the turbine blades. This enthalpy drop is converted into the kinetic energy of rotation of the blades mounted on the turbine drum. The turbine is well insulated which gives rise to the maximum work output. The turbine is well insulated.

$$Q = 0$$

Steam velocity at the turbine input = the steam velocity at the output

$$\text{i.e. } V_1 = V_2$$

The turbine is positioned horizontally

$$Z_1 = Z_2$$

Applying SFEE to the control volume

$$h_1 = h_2 + W$$

$$W = h_1 - h_2$$

$$= C_p (T_1 - T_2)$$

$$W = MC_p (T_1 - T_2)$$

### **perpetual motion machine**

PMMI refers to the perpetual motion machine of the first kind. It is a hypothetical machine that will continuously churn out work but without absorbing heat from its surroundings.

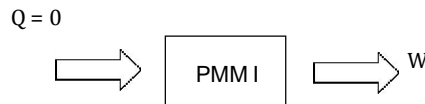

But such a machine is not feasible from a practical point of view, for it violates the law of conservation of energy (first law of thermodynamics).

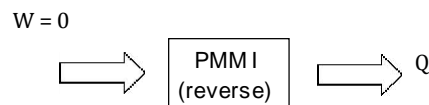

The reverse of perpetual machine is also not true. It is a hypothetical machine which is not feasible as it violates the first law of thermodynamics.

## SECOND LAW OF THERMODYNAMICS

### Limitation of first law

There are two basic limitations of the first law of thermodynamics

(1) First law does not differentiate between heat and work.

It assumes complete inter-convertibility of the two. Though work being a high grade energy can be fully converted into heat but heat cannot be completely converted to work.

(2) It does not permit us to know the direction of energy transfer. We cannot ascertain whether heat will flow from a higher temperature body to a lower temperature body vice versa.

### Thermal Reservoir

A thermal reservoir is a heat source or heat sink that remains at a constant temperature, regardless of energy interaction.

Otherwise a thermal energy reservoir (TER) is a large system body of infinite heat capacity which is capable of absorbing or rejecting a finite amount of heat without any changes in its thermodynamic co-ordinates.

The high temperature reservoir ( $T_H$ ) that supplies heat is a source.

Sink – Low temperature reservoir to which heat is rejected.

### Example

Ocean water and atmospheric air are two good examples.

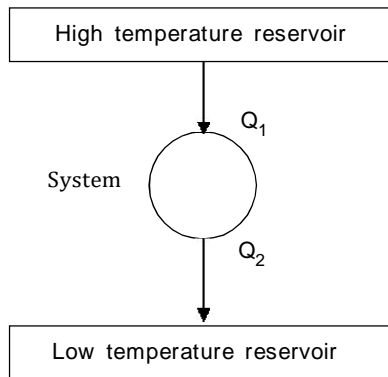

### Concept of heat engine

A heat engine is a device that can operate continuously to produce work receiving heat from a high temperature  $T_H$  and rejecting non-converted heat to a low temperature sink.

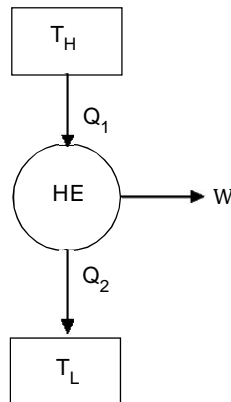

Effect  $\frac{\text{output } W}{\text{input } Q_1}$  —

But,  $W = Q_1 - Q_2$  in a cycle

So  $\frac{Q_1 - Q_2}{Q_1} = \frac{Q_2}{Q_1}$  —



thermal  $Q_1$   $Q_1$

## Heat Pump

A heat pump is a reversed heat engine. It receives heat from a low temperature reservoir (source) and rejects it to high temperature reservoir (sink) for which an external work which is supplied to the pump.

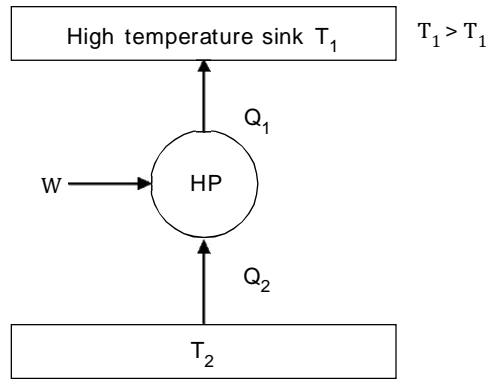

The efficiency of a heat pump cycle is usually called the coefficient of performance. It is the desired effect upon the external work supplied for obtaining that desired effect.

$$\text{COP} = \frac{\text{Desired effect}}{\text{Work input}}$$

$$\text{COP}_{\text{HP}} = \frac{Q_1}{W}$$

Again  $Q_1 = Q_2 + W$   
cycle cycle

$$Q_1 = Q_2 + W$$

$$\text{COP}_{\text{HP}} = \frac{Q_1}{Q_1 - Q_2}$$

## Refrigerator

A refrigerator is similar to a heat pump. It operates as a reversed heat engine. Its duty is to extract heat as much as possible from the cold body and deliver the same to high temperature body.

The desired effect of a refrigerator is to remove  $Q_2$  heat infiltrating into the cold space. By using the external work it rejects  $Q_1$  heat to the high temperature reservoir. Therefore,

$$\text{COP}_{\text{ref}} = \frac{Q_2}{W}$$

Again  $Q_1 = Q_2 + W$   
cycle cycle

$$Q_1 = Q_2 + W$$

$$\text{COP}_{\text{ref}} = \frac{Q_2}{Q_1 - Q_2}$$

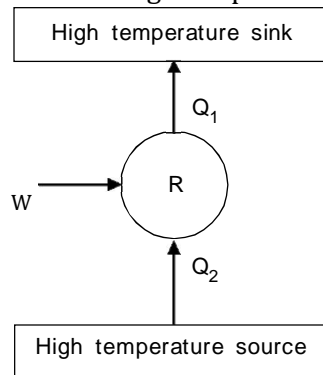

## Statement of second law of the thermodynamics

### Clausius statement

It is impossible to construct a device that will produce no effect other than the transfer of heat from a low temperature body to a high temperature body while operating in a cycle.

## Kelvin Planck statement

No heat engine, operating in cycle, can convert entire heat into work. It is impossible to build a heat engine that can register 100% efficiency.

**Note** –  $T_C$  K-P statement is of relevance to a heat engine. The C-statement relates more directly to a reversed heat engine.

## Perpetual motion machine II

It is a hypothetical machine that will continuously pump out heat from a low temperature reservoir ( $T_2$ ) and deliver the same to a high temperature reservoir at ( $T_1$ ) without taking up any input work from surroundings.

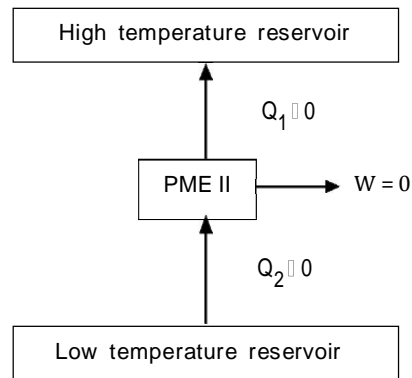

## Carnot cycle

The Carnot cycle is a hypothetical cycle developed by Nicholas Sadi Carnot (1796-1832), a French military engineer. It is meant for a heat engine or a reversed heat engine. All the processes involved in this cycle are reversible, thereby ensuring the best possible device that could be constructed. This cycle comprises 4 reversible processes.

### Process 1-2 reversible isothermal heat addition

Heat ( $Q_{add}$ ) flows from a high temperature reservoir to the working fluid which is at a constant temperature but only infinitesimally below that of the source.

$$Q_{add} = \int_1^2 U dV, \quad \int_1^2 U dV = 0$$

$$Q_{add} = W_{1 \rightarrow 2} \text{ (as isothermal process)}$$

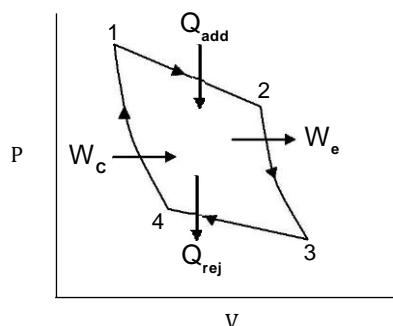

(a) PV diagram

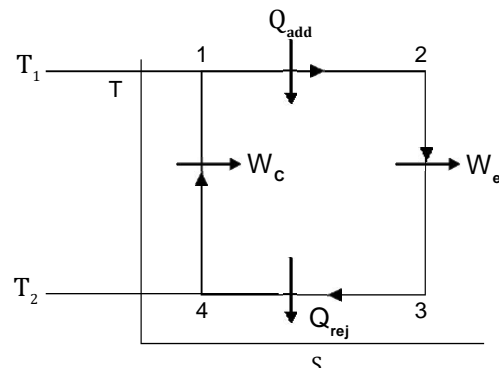

(b) TS diagram

### Process 2-3 (adiabatic expansion)

The working fluid expands through a turbine or expander adiabatically producing a net positive work output.

here  $Q = 0$



### Process 3-4 (Isothermal heat rejected)

Heat ( $Q_{rej}$ ) is rejected by the fluid to the sink-both one at a constant temperature, but differ only by an infinitesimal amount.

$\Delta U = 0$ , isothermal process

$$Q_{rej} = -W_{3-4}$$

–  $Q$  implies heat has been rejected by the system.

–  $W$  implies work has been done on the system.

### Process 4-1 (Reversible adiabatic compression)

The temperature of the working fluid is raised back to the temperature level of high temperature through adiabatic compression, i.e.  $Q = 0$

$$0 = \Delta U_{4-1} = W_{4-1}$$

$$\Delta U_{4-1} = -W_{4-1}$$

As the two isothermal and two adiabatic complete the cycle.

$$\text{So } Q_{net} = W_{net} \\ \text{cycle} \quad \text{cycle}$$

$$\text{Or, } Q_{add} = (Q_{rej}) = W_{1-2} = W_{2-3} = (W_{3-4} = W_{4-1}) Q_{add} = Q_{rej} \\ W_e = W_c$$

So, the efficiency

$$\eta = \frac{\text{Net work output}}{\text{heat input}} = \frac{W_e = W_c}{Q_{add}} \\ = \frac{Q_{add} - Q_{rej}}{Q_{add}} = \frac{Q_{rej}}{Q_{add}}$$

### Alite

1

Refer to the TS diagram

Net work done,  $W_{net} = \text{area } 1-2-3-4$

$$\text{Side } 1-4 \times \text{Side } 1-2$$

$$T_1 - T_2 \times S_2 = S_1 Q_{add}$$

$$T_1 S_2 = S_1 T_2$$

$$\text{So efficiency, } \eta = \frac{W_{net}}{Q_{add}} = \frac{T_1 - T_2}{T_1} = \frac{T_1 - T_2}{T_1}$$

**4.6. Application of second law is heat engine, heat pump, refrigerator and determine of cop and efficiencies.**

**Clausius statement**

According to second law without work input heat cannot flow from low temperature to high temperature.

**Case of heat engine**

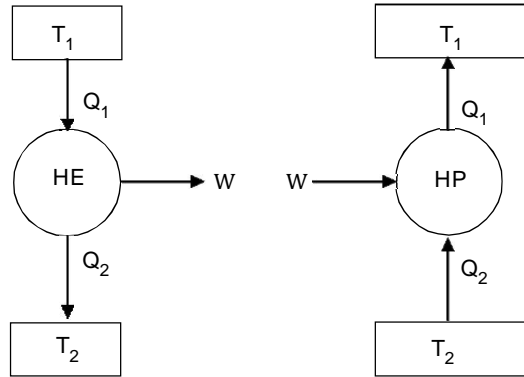

**Kelvin plank statement**

No heat engine operating in a cycle can convert entire heat into work.in the above engine.

$$Q_1 = Q_2 + W$$

that means,  $Q_2$  is rejected along with  $W$  output

$$Q_1 = W$$

**In a heat pump**

$$W + Q_2 = Q_1$$

$$W = 0, Q_2 = Q_1$$

which is impossible,  $W = 0$

**In a refrigerator**

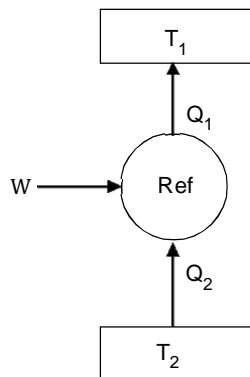

as like heat pump.

$$COP_{HP} = \frac{D.E}{Work_{input}} = \frac{Q_1}{Q_1 - Q_2} = \frac{T_1}{T_1 - T_2}$$

as  $\frac{Q_1}{T_1} = \frac{Q_2}{T_2}$  (according to Carnot's theory)

$$COP_{ref} = \frac{D.E}{Work_{ref}} = \frac{Q_2}{Q_1 - Q_2} = \frac{T_2}{T_1 - T_2}$$

$$COP_{ref} = \frac{T_2}{T_1 - T_2} = \frac{T_1 T_2}{T_1 - T_2}$$

$COP_{ref} = COP_{HP}$
------------------------

If installed backward, your household air conditioner will function as a heat pump cooling the surrounding but heating the room.

## THERMAL ENGINEERING

### WORKING SUBSTANCES

#### Pure Substance

Substance whose chemical composition is uniform throughout its mass. It should have the following properties.

- (i) Homogeneous in composition
- (ii) Homogenous in chemical aggregation
- (iii) Invariable in Chemical aggregation

#### (i) Homogeneous in composition

Composition of each part of the system is same.

#### (ii) Homogenous in chemical aggregation

Chemical elements must be combined chemically in the same way in all parts of the system.

#### (iii) Invariable in Chemical aggregation

The state of chemical combination of the system doesn't change with time.

#### Phase change of pure substance

Let the cylinder & piston machine contains a unit mass of ice at  $-10^{\circ}\text{C}$  under a pressure 'P' exerted by a weight W placed on the free frictionless piston.

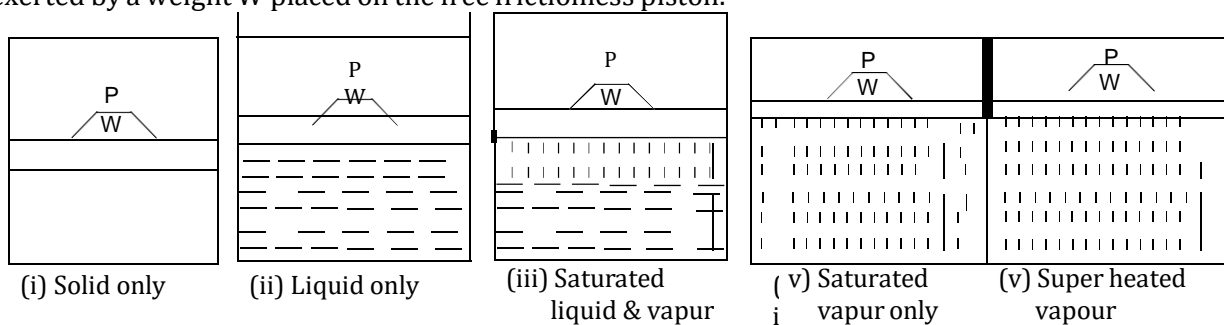

Let the ice be heated slowly so that its temp is always uniform. The changes which occur in the mass of water is as follows :

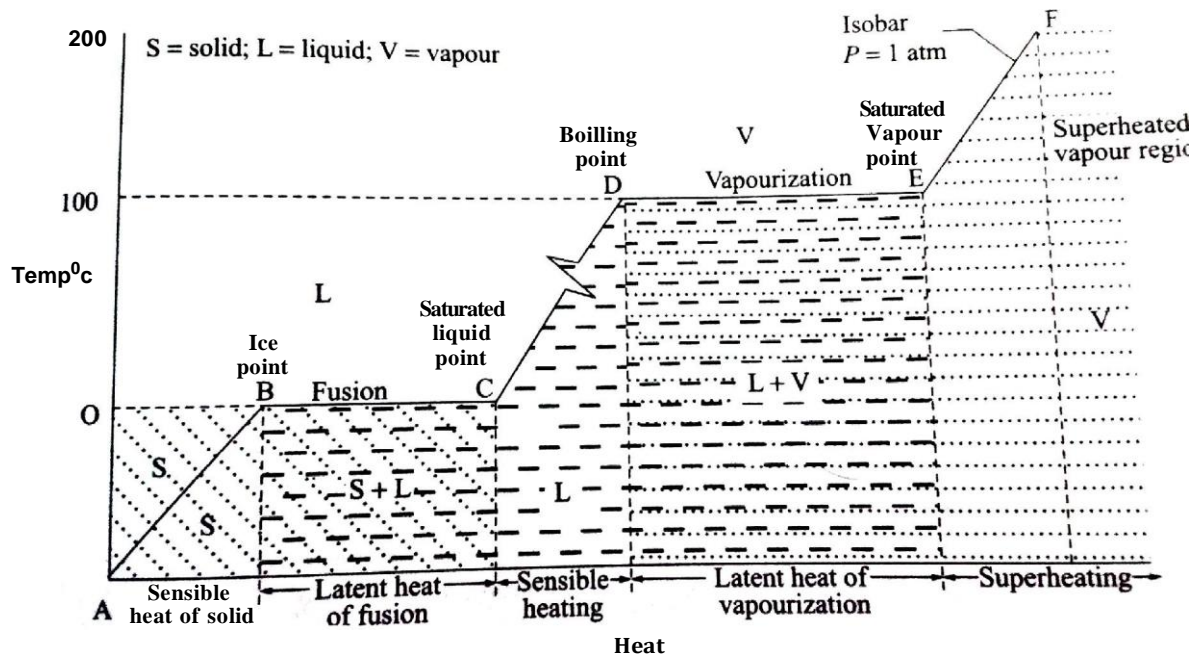



### Process A-B (Sensible heating of ice)

On heating the temp of ice increases from  $-10^{\circ}\text{C}$  to  $100^{\circ}\text{C}$ . The volume of ice also increases. The point 'B' is called as ice point or freezing point of water ( $0^{\circ}\text{C}$ )

### Process B-C (Fusion)

On heating the ice melts into water at a constant temp  $0^{\circ}\text{C}$ . The heat added during the process is called as latent heat of fusion or latent heat of ice.

The volume of the water decreases in comparison with ice  $0^{\circ}\text{C}$ . This is a peculiar characteristic of water. But all other pure substances increase their volume during this process.

The process in opposite direction (C-B) is called solidification.

### Process C-D (Sensible heating of water)

On heating the temp of water increase from  $0^{\circ}\text{C}$  to  $100^{\circ}\text{C}$ . The volume of water increases due to thermal expansion.

### Process D-E (Vapourisation)

On heating the water starts boiling to vapour at constant temperature of  $100^{\circ}\text{C}$ . The heat added during the process is called latent heat of vapourisation. The volume of the mixture of water & vapour increases. The vapour at state 5 is dry saturated. The process in opposite direction (E-D) is called condensation.

### Process E-F (Superheating)

On heating the saturated vapour at E gets superheated & temp of the vapour increases to say  $200^{\circ}\text{C}$ . The volume of the vapour also increases to height extent. The rise in temperature during the process is called as degree of superheat. The heat added during this process is called as heat of superheat.

### P-V diagram

(i) For water

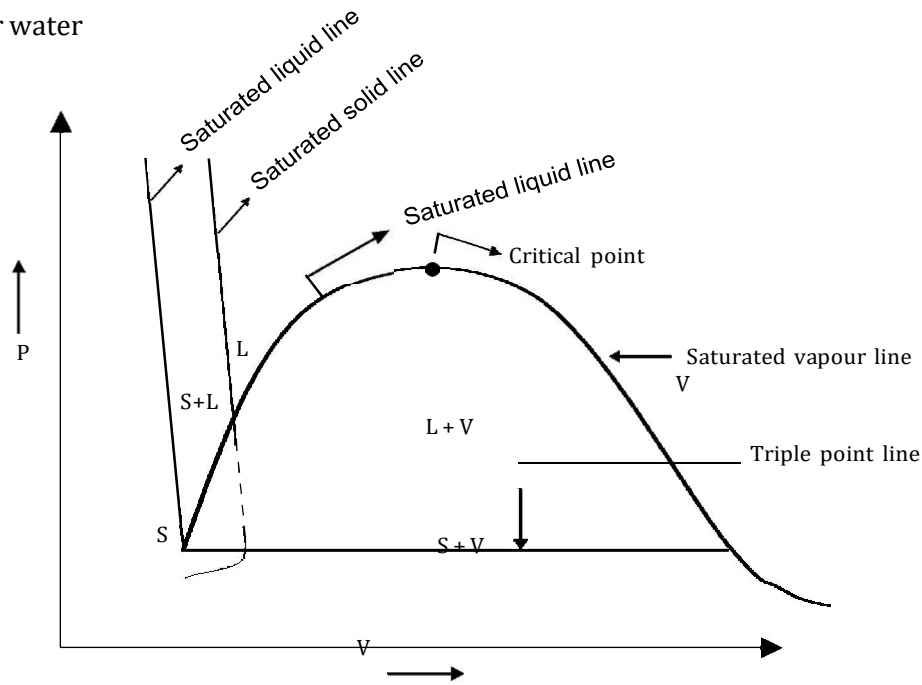

(ii) For all pure substances

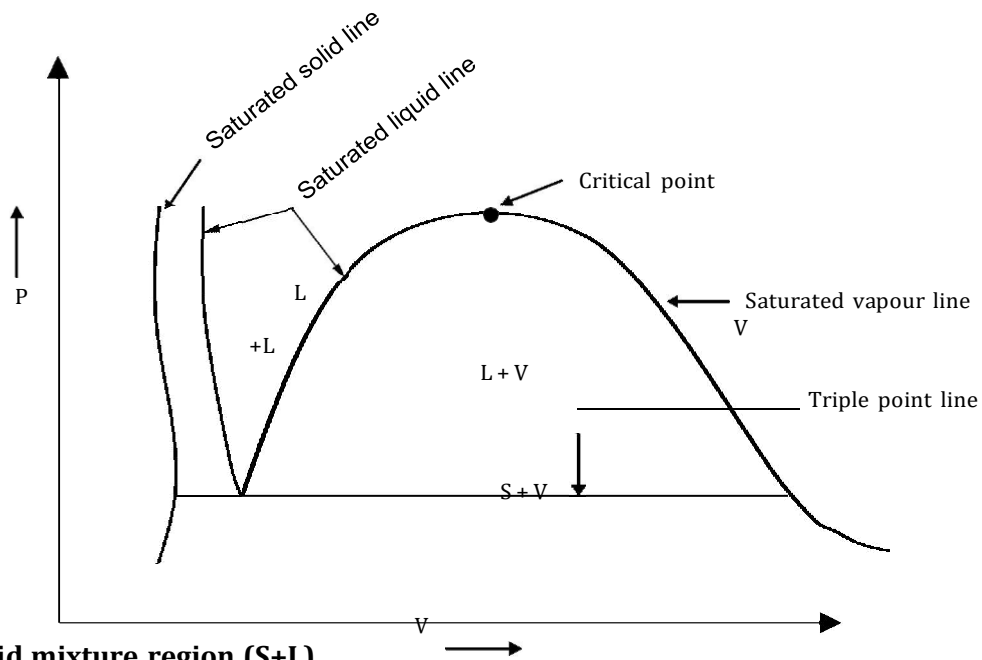

**Solid-liquid mixture region (S+L)**

The space between saturated solid line & saturated liquid line with respect to the solidification is called solid-liquid mixture region.

**Solid region (S)**

The space left to the saturated solid line is called solid region.

**Liquid region (L)**

The space between 2 saturated liquid line is called liquid region.

**Liquid-vapour mixture region (L+V)**

The space between saturated liquid line w.r.t vapourisation & saturated vapour line is called liquid-vapour mixture region.

**Triple point line**

It is a line on P-v diagram, where all these phases exist in equilibrium.

**Solid vapour mixture region (S+V)**

The space below the triple point line is called solid vapour mixture region.

**Critical point**

The point at which the saturated liquid line & saturated vapour line meet each other is known as critical point.

Above the critical point, the liquid on heating suddenly converted into vapour or the vapour on cooling suddenly converted into liquid.

The pressure, temperature & volume w.r.t critical point are known as critical pressure, critical temp & critical volume respectively.

**For water**

$$P_c = 221.2 \text{ bar } T_c = 374.150^\circ\text{C}, V_c = 0.00317 \text{ m}^3 / \text{kg}$$

**Saturated temperature**

The temperature at which a pure liquid (at a given pressure) changes into vapour.

## Saturated pressure

At a give temperature a pure liquid changes into pressure. That particular pressure is called saturated pressure.

### P-T diagram

(i) For water

$T_t = 273.16\text{K}$   
 $P_t = 4.58\text{mmHg}$   
 (t = triple point)

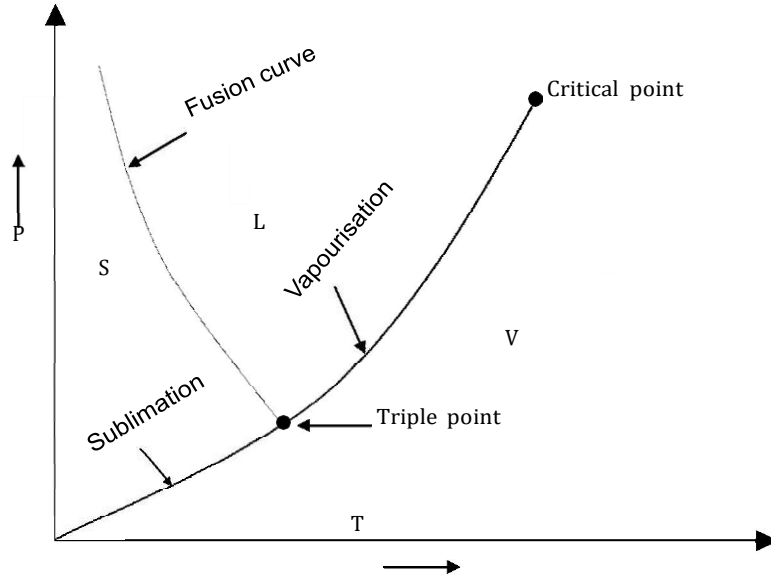

$T_t = 273.16\text{ K}$ ,  $P_t = 4.58\text{mmHg}$ , (t = triple point)

(ii) For pure substances

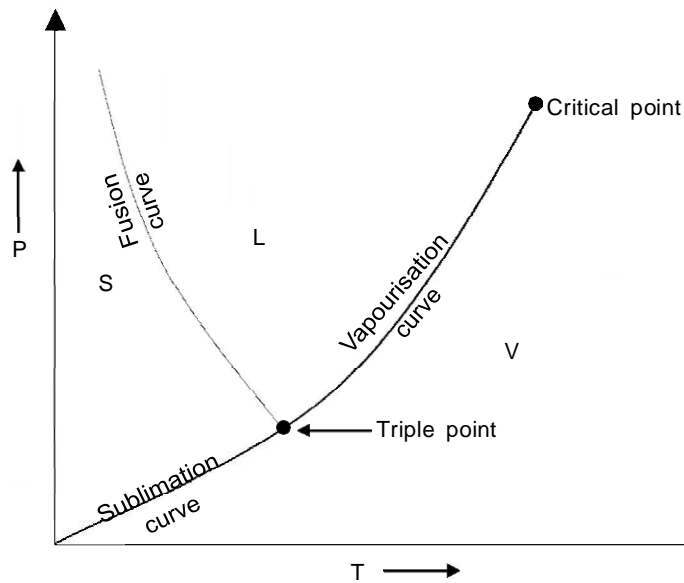

### Specified heat :

(i) It is defined as the amount of heat required to raise the temperature of a unit mass of substance through unit degree.

$$(ii) C = \frac{Q}{M \times \Delta t} \quad \text{unit}(\text{J}/\text{kg} \cdot \text{K})$$

M = mass of substance

$\Delta t$  = rise or fall of temperature.

(iii) Specific heat at constant pressure is called  $C_p$ . Specific heat at constant volume is called  $C_v$ .

(iv) It doesn't depend upon path.

### Quality or dryness fraction :

It is defined as the ratio of mass of dry steam actually present to the total mass of the vapour which contains it.

$$\text{Dryness fraction} = \frac{\text{dry steam mass}}{\text{total mass of vapour}}$$

$$X = \frac{M_g}{M_g + M_f} = \frac{M_g}{M}$$

$M_g$  = mass of dry vapour,  $M_f$  = mass of liquid particle,  $M$  = total mass =  $(M_g + M_f)(1 - x)$  = wetness fraction

$$\text{wetness fraction} = \frac{\text{mass of liquid particle present}}{\text{total mass of steam}}$$

For dry saturated vapour, quality = 100% i.e.  $x = 1$

$$(i) \quad V = V_f + V_g$$

$V_f$  = volume of liquid particle present

$V_g$  = volume of vapour present.

$$V = V_f + x V_{fg}$$

$$V_{fg} = V_g - V_f$$

$$S_{fg} = S_g - S_f$$

$$h_{fg} = u_g - h_f$$

$$S = S_f + x S_{fg}$$

Heat of superheat ( $h_s$ ) =  $C_p (T_{sup} - T_{sat})$

$T_{sup} - T_{sat}$  = degree of superheat

### Steam Table

The properties of water are arranged in the steam table as the function of temperature & pressure. If given temp > steam table temperature.

Then it is a case of superheat.

$$V = V_1 \frac{V_2}{V_1} \frac{T_2}{T_1} \text{ given } T$$

$$h = h_1 \frac{h_2}{h_1} \frac{T_2}{T_1} \text{ given } T$$

$$S = S_1 \frac{S_2}{S_1} \frac{T_2}{T_1} \text{ given } T$$

Similarly if given volume > steam table volume. It is a case of superheat

$$T = T_1 \frac{T_2}{T_1} \frac{V_2}{V_1} \text{ given } V$$

$$h = h_1 \frac{h_2}{h_1} \frac{V_2}{V_1} \text{ given } V$$

$$S = S_1 \frac{S_2}{S_1} \frac{V_2}{V_1} \text{ given } V$$

$$1 \quad V \quad V \\ 2 \quad 1$$

# Mollier diagram

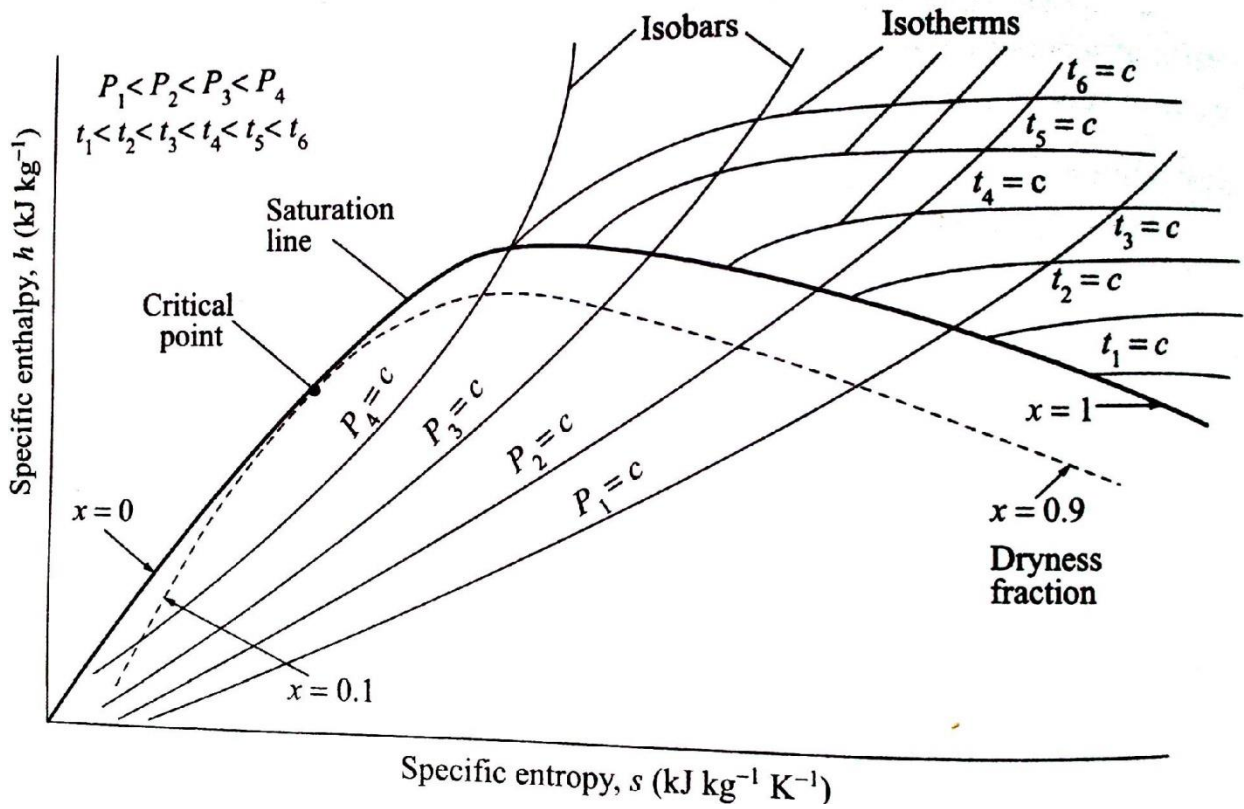

Constant pressure line =  $P_1, P_2, \dots$  etc.  
 Constant temperature line =  $t_1, t_2, \dots$  etc.

## CHAPTER 6.0

### IDEAL GASES & REAL GASES

#### 6.1. Boyle's Law

The volume of a given mass of gas is inversely proportional to its absolute pressure at constant temperature.

$$\text{i.e. } V \propto \frac{1}{P} \text{ (T = constant)}$$

$$PV = \text{constant}$$

#### Charles's Law

The volume of a given mass of a gas directly proportional to its absolute temp at constant pressure.

$$\text{i.e. } V \propto T \text{ (P = constant)}$$

$$\frac{V}{T} = \text{Constant}$$

#### Ideal gas Law

From Boyle's law  $PV = C$

$$\text{Charles's law } \frac{V}{T} = C$$

Combining both the law

$$PV = C T$$

$$\text{i.e. } PV \propto T$$

$$PV = RT \quad \dots(i)$$

This equation is called characteristic gas equation or ideal gas equation.  $R$  = characteristic gas constant  
= 0.287 KJ / Kg-k (for atm. air)

#### Universal gas constant ( $R_u$ ).

In general  $PV = mRT$  ( $m$  = mass of gas)

But  $m = nM$

$n$  = no of kg moles

$M$  = Molecular mass of the gas

$$\therefore PV = nMRT$$

$$= n (MR)T = nR_u T \dots$$

$R_u$  = universal gas constant =  $M.R$

$M.R$  = constant of all the gases.

$$R_u = 8.3143 \text{ KJ/ Kgk}$$

**Avogadro's law :**

It states that the equal volumes of different ideal gases at the same temperature & pressure contains equal number of molecules.

$$n \propto \frac{m_1}{M_1} + \frac{m_2}{M_2} + \frac{m_3}{M_3} + \dots$$

but  $M \propto v$

$$n \propto \frac{1}{M_1} + \frac{1}{M_2} + \frac{1}{M_3} + \dots$$

$\rho$  = Mass density  $\propto \frac{1}{V}$

$V$  = Specific volume

$$n \propto \frac{1}{M_1 V_1} + \frac{1}{M_2 V_2} + \frac{1}{M_3 V_3} + \dots$$

$$M_1 V_1 = M_2 V_2 = M_3 V_3 = \dots = \text{Constant}$$

SP volume molecular weight = Molar volume

$$V.M = \bar{V}$$

**Dalton's law :**

(i) The pressure of a mixture of gasses is equal to the sum of the partial pressure of the constituents.

(ii) The partial pressure of each constituent is that pressure which the gas would exert if it occupied alone at that given volume occupied by the mixture at the same temperature.

$$P = P_A + P_B$$

(iii) It is found the dalton's law is more accurately by gas mixtures at low pressure.

$$P = P_A + P_B + \dots + P_n = \sum P_i$$

$P_i$  = Partial pressure of the constituent.

**Work done in moving the boundaries of a closed system**

Consider a gas of contained in a piston-cylinder arrangement pressure exerted by the gas is  $P$  on the cross sectional area of piston  $A$ .

Let the piston moves a distance  $dl$  Work done = Force x displacement

$$= (P.A) \times dL \quad \left[ \begin{matrix} P_i \\ P_A \end{matrix} \right]$$

$$= P \cdot dv \quad \left[ A \cdot dL = dv \right]$$

Suppose, gas expands from 1 to 2

$$\text{the W.D} = \int_{v_1}^{v_2} P \cdot dv$$

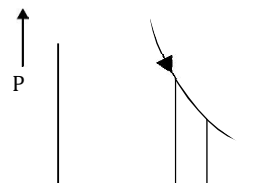
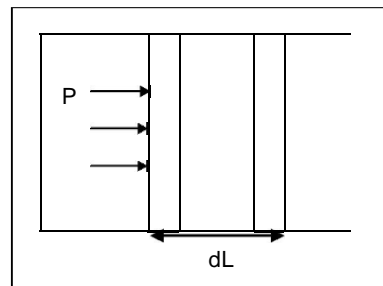





W.D by the system is +ve  
 W.D on the system is -ve

**Constant volume process**

$W.D = P \cdot dv = 0$

$dw = 0$

$dQ = MC_v \cdot dT$  (heat supplied)

According to 1st law of thermodynamics

$dQ = dw + du$

$MC_v \cdot dT = 0 + du$

$U = MC_v (T_2 - T_1)$  (Isochoric process)

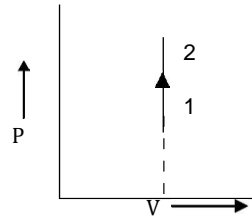

**Constant pressure process (Isobaric process)**

$dw = P dv$   
 $= P(V_2 - V_1)$   
 $= P V_2 - P V_1 = MR(T_2 - T_1)$   
 $P_2 = P_1 = P$

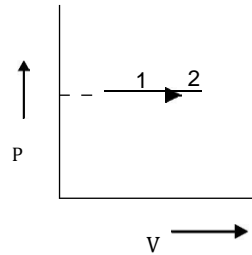

$dQ = mC_p dT$   
 $= mC_p (T_2 - T_1)$   
 $dU = mC_p (T_2 - T_1) - mR(T_2 - T_1)$   
 $= mC_v (T_2 - T_1)$   
 $C_p = C_v + R$

**Constant temperature process (Isothermal process)**

$PV = C$

$P = \frac{C}{V}$

$dw = P dv$

$= \int_{V_1}^{V_2} \frac{C}{V} dv$

$= C \ln \frac{V_2}{V_1}$

$= C \ln v_2 - C \ln v_1$

$= C \ln \frac{V_2}{V_1} = PV \ln \frac{V_2}{V_1} = P V \ln \frac{V_2}{V_1}$

$= mRT \ln \frac{V_2}{V_1}$

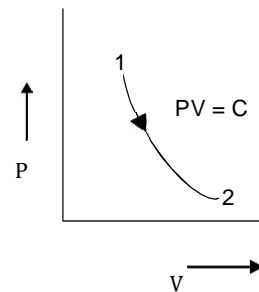

$$\begin{aligned}
 & \Delta V \\
 & \Delta U = mC_v(T_2 - T_1) = 0 \\
 & T_2 = T_1 \\
 & Q = W = U_2 - U_1 \\
 & \boxed{Q = W}
 \end{aligned}$$

## Isentropic process

No heat transfer between the system & the surrounding.

Constant pressure process (Isobaric process)  $PV^C = C$

$$dw = P \cdot dv = C \frac{V_2 dv}{V}$$

$$C \int_{V_1}^{V_2} \frac{1}{V} dV = \int_{P_1}^{P_2} \frac{1}{P} dP$$

$$C \ln \frac{V_2}{V_1} = \ln \frac{P_2}{P_1}$$

$$\frac{P_1 V_1^C}{P_2 V_2^C} = \frac{P_2 V_2^C}{P_2 V_2^C}$$

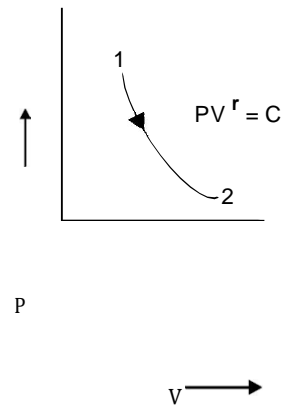

$$Q = 0$$

$$U = W$$

## Vander walls equation

$$P = \frac{RT}{V - b} - \frac{a}{V^2}$$

$a, b$  = Specific constant & depend upon the type of the fluid.  $V$  = volume per unit mass,  $R$  = gas constant.  
If volume of 1 mole is considered

$$P = \frac{RT}{V - b} - \frac{a}{V^2}$$

$P, V, T, R, a, b$  units are as follows

$$P = \frac{\text{N}}{\text{M}^2}, V = \frac{\text{M}^3}{\text{kg}}, T = \text{K}, R = \frac{8314 \text{ NM}}{\text{kgmol} \cdot \text{K}}$$

$$a, b = \frac{\text{NM}^4}{\text{kgmol}^2}, b = \frac{\text{M}^3}{\text{kg}}$$

## Difference between Real gas & Ideal gas

### Real gas

(i) No gas flows all conditions of gas law under certain conditions of pressure & temperature but it approaches the ideal gas behavior. Hence it is called real gas.

(ii) The relations derived from ideal gas may

(iii) In certain condition real gas no more remain in gaseous phase but changes its state. So real gases under certain condition behaves like ideal gas.

### **Ideal gas**

- (i) A gas which obeys all the laws of gas under all conditions of temperature & pressure.
  
- (ii) Ideal gas law is simple & hence simple relations are derived from it.
  
- (iii) O<sub>2</sub>, N<sub>2</sub>, H<sub>2</sub> may be treated as ideal gas because ordinarily these are difficult to liquefy.